

PANEL FENCE TYPE A - WOVEN TIMBER PANEL

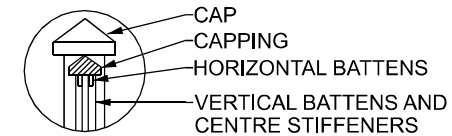

DETAIL A

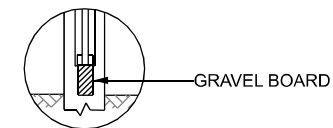

DETAIL B

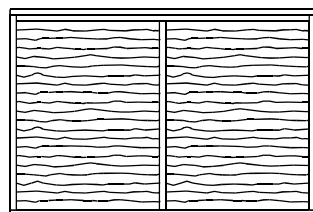

FRONT



SIDE

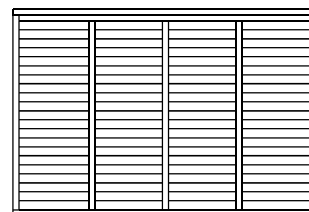

REAR

PANEL FENCE TYPE B - OVERLAPPING HORIZONTAL BOARD PANEL

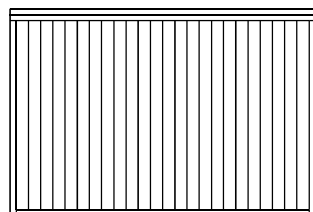

FRONT



SIDE

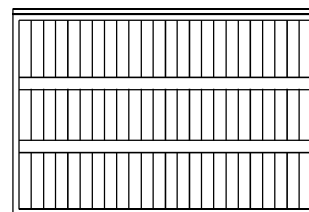

REAR

PANEL FENCE TYPE C - OVERLAPPING VERTICAL BOARD PANEL

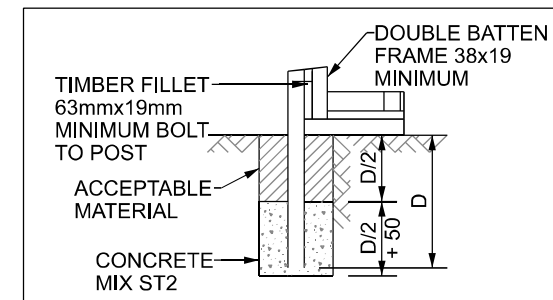

CONCRETE POSTS

NOTES:-

1. ALL DIMENSIONS ARE IN MILLIMETRES.
2. B.S. 1722 PART 2 APPLIES UNLESS OTHERWISE STATED.
3. DIMENSIONS AND SIZES OF POST AND INFILL SHALL BE TAKEN FROM B.S. 1722 PART 2 AS APPROPRIATE TO THE HEIGHT AND TYPE OF FENCE DESCRIBED IN APPENDIX 1/ 15 AND ON THE DRAWINGS.
4. ALL TIMBER SHALL COMPLY WITH CC-SPW-00300 UNLESS OTHERWISE STATED IN APPENDIX 1/ 15.
5. TIMBER POST MAY ONLY BE DRIVEN OR SUPPORTED IN RAMMED BACKFILL WHERE STATED IN APPENDIX 1/ 15.
6. THIS SCD IS NOT TO BE USED FOR ENVIRONMENTAL NOISE BARRIER.



PUBLICATION TITLE
FENCING
WOVEN AND LAP BOARDED PANEL FENCE

ACTIVITY	PUBLICATION TITLE			PUBLICATION NUMBER	
STREAM	HISTORICAL REFERENCE	DOCUMENTATION SET	PUBLICATION DATE	ACTIVITY	STREAM
STANDARD CONSTRUCTION DETAILS (SCD)	RCD/300/7	STANDARDS	JANUARY 2007	CC	SCD
				DRAWING NUMBER	
				00307	